



DV-5470

User Manual

Package Contents:

Manual
Camera Pouch
Installation CD
Earbuds
AV Cable

CONTENTS

1. NOTICE.....	2
2. SETUP	3
2.1 BATTERY INSTALLATION	3
2.2 MEMORY CARD	4
2.3 CONFIGURATION & INSTALLATION	4
3. MENU SETUP	5
4. BASIC FUNCTIONS.....	10
4.1 VIDEO MODE	10
4.2 CAMERA MODE	12
4.3 PLAYBACK	18
4.4 MUSIC	20
4.5 PHOTO PREVIEW	21
4.6 RECORD (VOICE RECORDING)	23
5. USB MODE	23
6. TECHNICAL PARAMETERS:.....	364

Thank you for purchasing the Argus DV-5470 Digital Video Camera

1. **Notice**

Carefully rotate the LCD, Damage will be caused by over rotating.

- a. Open LCD and push it to 90⁰ against the body
- b. Start to capture or play with LCD at the appropriate angle.

LCD and lens maintenance:

- a. Direct sunlight may cause the damage of the LCD.
- b. Only clean the lens and LCD screen with a soft cloth.

Caution:

- a. Do not store the camera in temperatures above 100 .
- b. Keep the DV Camera away from moisture. Getting the camera wet will damage it and void the warranty.
- c. Condensation may appear with sudden changes in temperature. Take care to not leave the camera in extreme temperatures.

Copyright Infringement:

TV programs, DVD programs and, movies are protected by copyright; unauthorized copying may result in infringement.

Maintenance and components

- a. Do not try to repair your DV camera by yourself.
- b. Opening the cover of the Camera may cause electrical shock and will

void your warranty.

- c. Please consult with a qualified technician for maintenance.
- d. Any use of the unrecognized components may cause fire, electrical shock or other dangers.

2. Installation

2.1 installation of the battery

- 1). Push the battery door at the bottom of the DV.
- 2). Open the battery door.
- 3). Inset the battery according to the positive pole.

Notice to the battery security

- 1). The lithium battery keeps the clock running and internal flash memory when the AC adapter is unconnected.
- 2). In the proper condition, the lithium battery usually lasts for 3 hours after it's fully charged.

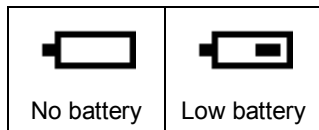

- 3). Charge the battery when the signal as above said appears.
- 4). Consult Technical Support if the battery needs replaced.

ATTENTION : Please keep the battery away from children.

2.2 Memory card

- 1) Open the battery cover of the DV.
- 2) Insert the card with the reverse side against the positive side of DV.
- 3) Close the battery cover.

Attention: keep the card in “unlock” status. All data will be deleted if you format the memory card, please backup the file before format.

The memory cards available to the product:

- 1) Standard SD card (8MB—1G)
- 2) Memory sticks with 3V or 3.3v (8M—1G)
- 3) SD card with 5v is not available.
- 4)The product may not identify the non-standard memory sticks or the SD card formatted in other products, please format it by this product before use.

2.3. Configuration & installation

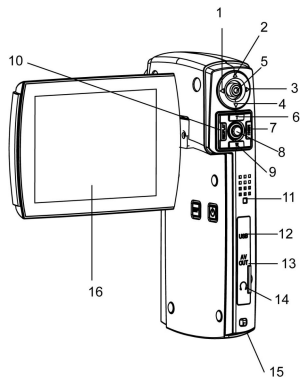
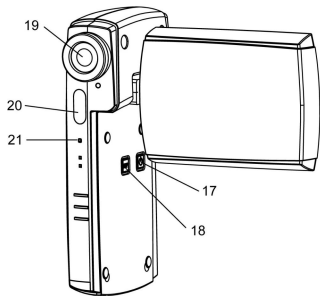

1. Left
2. up
3. right
4. down
5. OK button
6. Zoom out
7. Menu button
8. Shutter button
9. zoom in
10. REC/PLAY
11. speaker

12. USB interface
13. AV out
14. earphone
15. battery door/SD card slot
16. LCD display
17. Power on
18. DISP
19. lens
20. flash light
21. microphone

3. Menu setup

How to enter menu setup

- 1). POWER on ;
- 2). Press “REC/PLAY” button , Push the 5-way button left/right to select “setup” icon.
- 3). Press the “OK” button to enter “setup” menu.

3.1 Flicker frequency

Set the light frequency according to different countries:

- 1). Power on and press “REC/PLAY” button to enter “Setup” menu;
- 2). Press the 5-way button to select “flicker frequency” icon, then press the “OK” button to enter;
- 3). Press the 5-way button up/down to select “60HZ” or “50HZ”;
- 4). Press the “OK” button to select the right frequency.
- 5). Press “REC/PLAY” or “MENU” button to return to the main menu.

3.2 Time

Please set the time (date / time) before recording, since it will show on the image or video automatically.

- 1) Power on and press “REC/PLAY” button to enter “Setup” menu;
- 2) Push the 5-way button left/right to select “time”
- 3) Press the “OK” button to confirm and enter the time setup;
- 4) Push the 5-way button right/left to select minute, hour, day, month and year, push 5-way button up/down to modify them;
- 5) Press “REC/PLAY” or “MENU” button to return to the main menu.

3.3 Beep

- 1) Power on and press “REC/PLAY” button to enter “Setup” menu;
- 2) Push the 5-way button left/right to select “Beep”;
- 3) Press the “OK” button to enter the beep setup, select “on” or “off”;
- 4) Press “REC/PLAY” or “MENU” button to return to the main menu.

3.4 Memory card format

1. Set the memory card in “UNLOCK” status;
2. Insert the memory card into the card slot and power on;
3. Press “REC/PLAY” button to enter “SETUP” menu ;
3. push the 5-way button left/right to select “format”;
4. Press the “OK” button to confirm, then press 5-way button up/down to select “Yes” to start formatting;
5. Formatting may lasts 2 – 3 minutes, then return to the submenu automatically;
- 7 : Press “REC/PLAY” or “MENU” button to return to the main menu.

3.5 Media select

**The Internal flash of this model is 128MB, external card is optional.
You can choose to save in the internal flash or external card.**

- 1) Power on and press “REC/PLAY” button to enter “Setup” menu;
- 2) Push the 5-way button up/down to select “media select” icon;

- 3) Press the “OK” button to enter media selecting setup, both internal flash and external card can be selected;
- 4) Push the 5-way button up/down to select “internal flash” or “external card”, press the “OK” button to confirm and return to the submenu,
- 5) Press “REC/PLAY” or “MENU” button to return to the main menu.

Note: the default setting is “External card” when the memory card is inserted; otherwise, the default setting is “internal flash”.

3.6 Default setting

- 1). Power on and press “REC/PLAY” button to enter “Setup” menu;
- 2). Push the 5-way button to select “default setting”;
- 3). Press the “OK” button to enter default setting setup
- 4). Push the 5-way button up/down to select “yes” or “no”, then press the “OK” button to confirm and return to the submenu.
- 5). Press “REC/PLAY” or “MENU” button to return to the main menu.

Note: all settings of the submenu will restore to the default setting when you select “Yes”.

3.7 Language

- 1) Power on and press “REC/PLAY” button to enter “Setup” menu;
- 2) Push the 5-way button left/right to select "language" ;
- 3) Press the “OK” button to confirm and enter the language setting;

- 4) Push the 5-way button up/down to select the language you prefer, then press the “OK” button to confirm and return to the submenu
- 5) Press “REC/PLAY” or “MENU” button to return to the main menu.

3.8 Power save (Auto power off)

You can set the auto power off time to save the battery;

- 1). Power on and press “REC/PLAY” button to enter “Setup” menu;
- 2). Push the 5-way button left/right to select “power save” ;
- 3). Press the “OK” button to confirm and enter “power save” setting;
- 4). Push the 5-way button to confirm and enter, you can select “none”, “60s”, “2min”, press the “OK” button to confirm and return to the submenu.
- 5). Press “REC/PLAY” or “MENU” button to return to the main menu.

Note: auto power off can not be performed when “none” is selected.

3.9 TV mode

- 1). Power on and press “REC/PLAY” button to enter “Setup” menu;
- 2). Push the 5-way button left/right to select “TV mode”;
- 3). Press the “OK” button to confirm and enter the TV mode setting;
- 4). Push the 5-way button up/down to select “NTSC” or “PAL”, then press the “OK” button to confirm and return to the submenu;
- 5). Press “REC/PLAY” or “MENU” button to return to the main menu.

3.10 Logo display

- 1). Power on and press “REC/PLAY” button to enter “Setup” menu;
- 2). Push the 5-way button left/right to select “logo display”;

- 3). Press the “OK” button to confirm and enter the logo display setting, select “open” or “close”;
- 4). Push the 5-orientation key upwards or downwards to select “on” or “off”, press the “OK” button to confirm and return to the submenu,
- 5). Press “REC/PLAY” or “MENU” button to return to the main menu.

3.11 Brightness

- 1). Power on and press “REC/PLAY” button to enter “Setup” menu;
- 2). Push the 5-way button left/right to select “brightness”;
- 3). Press the “OK” button to enter the brightness setting;
- 4). Push the 5-way button left/right select the brightness level you prefer, then press the “OK” button to confirm and return to the submenu;
- 5). Press “REC/PLAY” or “MENU” button to return to the main menu.

4. Basic functions

There are 6 basic functions of this product: V Camera, camera, video, mp3, JPEG, record.

4.1. Video mode

- 1). Power on and enter video mode automatically ;
- 2). Press the “shutter” button to start video clip;
- 3). Press the “shutter” button again to end video clip.

Notice: The video clip time depends on the memory capacity.

In the video mode, Press “MENU” button to enter the submenu to set the resolution, frame rate, audio and white balance.

a. Resolution

1. In the video mode, press the “MENU” button to enter the submenu:
2. Push the 5-way button to left/right to select “resolution”:
3. Press the “OK” button to confirm and select the resolution: “640*480” or “320*240”;
4. Push the 5-way button up/down to select the resolution you prefer
5. Press the “OK” button to confirm and return to the submenu of video mode;
6. Press the “MENU” button to return to the video mode ;

b. Frame rate

1. In the video mode, press the “MENU” button to enter the submenu;
2. Push the 5-way button to left/right to select “frame rate”;
3. Press the “OK” button to confirm and enter the setting of frame rate: “30fps” or “15fps”
4. Push the 5-way button up/down to select the frame rate you prefer;
5. Press the “OK” button to confirm and return to the submenu of video mode;
6. Press “MENU” button to return to the video mode;

Notice: the higher the frame rate, the shorter the video clip time, and the frame rate also affects the video quality.

c. Audio

Voice recording is performed if you select audio function in the video mode;

1. In the video mode, press the “MENU” button to enter submenu;
2. Push the 5-way button left/right to select “Audio”;
3. Press the “OK” button to confirm and enter audio setting “on” or “off”;
4. Push the 5-way button up/down to select “on”;
5. Press the “OK” button to confirm and return to the submenu of video mode;
6. Press the “MENU” button to return to the video mode;

d. White balance

Proper white balance can help to obtain the optimized the video clip.

1. In the video mode, press the “MENU” button to enter the submenu;
2. Push the 5-way button left/right to select “white balance”;
3. Press the “OK” button to confirm, white balance option: “auto”, “daylight”, “Tungsten”, “fluoresce” and “cloudy”;
4. Push the 5-way button up/down to select the white balance you prefer;
5. Press the “OK” button to confirm and return to the submenu of video mode;
6. Press the “MENU” button to return to the video mode.

4.2. Camera mode

1. Power on and enter the Camera mode ;
2. Press “REC/PLAY” button to enter the main menu;
3. Push 5-way button left/right to select “Camera”;
4. Press the “OK” button to enter Camera mode;
5. Press the “shutter” button to start capture

Notice:

1. Press the “shutter” button slightly to start capture;
2. Do not open the battery door to take out the battery or SD card during the image saving status. Otherwise, it may cause the image lost or damaged.

4.2.1 Digital zoom

How to use digital zoom?

1. Press “T” or “W” button to adjust the digital zoom in “camera” mode;
2. Press the “Shutter” button to start capturing.

Notice: To zoom in more, the lower quality of the image.

In order to obtain the optimized effect, you can adjust in the submenu under the Camera mode: capture mode, date stamp, flash mode, scenery, EV, quality, resolution, white balance, color and quick preview.

a. Capture mode

You can select “single”, “sequence (continuous capture)”, “10s timer”, “20s timer” in camera mode.

1. In the Camera mode, Press the “menu” button to enter the submenu;
2. Push the 5-way button to left/right to select “capture mode”;
3. Press the “OK” button to confirm and select “single”, “sequence”, “10s

timer”, “20s timer”;

4. Push the 5-way button up/down to select;
5. Press the “OK” button to confirm and return to the submenu of Camera mode.



Notice: the maximum shooting is 3 images when in “sequence” mode.

b. Date stamp

1. You can set the minute, hour, day, month and year firstly in the “time” mode of the “setup” menu;
2. Press the “REC/PLAY” button to return to the main menu;
3. Press the “menu” button to enter the submenu in camera mode;
4. Push the 5-way button left/right to select “date stamp”;
5. Press the “OK” button to confirm, select “on” or “off”;
6. If you set it to “ON”, the time will be displayed at the right corner in each image.

c. Flash mode

	Auto: Automatically turn on/off according to the light
---	--

	Force on: Force on the flash
	Force off: Force off the flash

Flash setting :

1. In Camera mode, press the “MENU” button to enter the submenu;
2. Push the 5-way button left/right, select “flash mode”;
3. Press the “OK” button to confirm, set flash by “force on”, “auto”, “force off” ;
4. Push the 5-way button up/down to select the flash mode;
5. Press the “OK” button to confirm and return to the submenu of Camera,

Notice:

The flash distance is approximately 1.8 – 2.5 M.

d. Scenery

Scenery setting helps to reach the optimized effect in different scenery.

1. In Camera mode, press the “MENU” button to enter the submenu;
2. Push the 5-way button left/right to select “scenery”;
3. Press the “OK” button to confirm and select “auto”, “scenery”, “night scene”;
4. Push the 5-way button up/down to select the scenery you prefer;
5. Press the “OK” button to confirm and return to the submenu of Camera

e. Exposure compensation (EV)

EV can be set to 2.0 when the light is insufficient.

1. In Camera mode, press the “MENU” button to enter the submenu;
2. Push the 5-way button left/right to select “EV”;
3. Press the “OK” button to confirm;
4. Push the 5-way button up/down to adjust exposure compensation from 0 – 2.0;
5. Press “REC/PLAY” button to return to the main menu;
6. Push the 5-way button left/right to select camera mode, press the “OK” button to confirm and start capturing according to the new EV.

f. Image quality

1. In Camera mode, press the “MENU” button to enter the submenu;
2. Push the 5-way button left/right to select “quality”;
3. Press the “OK” button to confirm and select “super”, “fine” or “normal”;
4. Push the 5-way button up/down to select the quality;
5. Press the “OK” button to confirm and return to the submenu of Camera.

g. Resolution

The resolution of the image can be as follows:

3648X2736, 2592x1944, 2048x1536, 1600x1200, 1280x960, 640x480

1. In Camera mode, press the “MENU” button to enter the submenu;
2. Push the 5-way button left/right to select “resolution”;
3. Press the “OK” button to confirm;
4. Push the 5-way button up/down to select the resolution you prefer;
5. Press the “OK” button to confirm and return to the submenu of

Camera;

6. Press the “MENU” button to return to the camera mode.

h. White balance

Proper white balance can help to obtain the optimized image effect.

1. In the camera mode, press the “MENU” button to enter the submenu;
2. Push the 5-way button left/right to select “white balance”;
3. Press the “OK” button to confirm, white balance option: “auto”, “daylight”, “Tungsten”, “fluoresce” and “cloudy”;
4. Push the 5-way button up/down to select the white balance you prefer;
5. Press the “OK” button to confirm and return to the submenu of camera mode;
6. Press the “MENU” button to return to the camera mode.

i. Color

You can select your favorite background color.

1. In Camera mode, press the “MENU” button to enter the submenu;
2. Push the 5-way button left/right to select “color”;
3. Press the “OK” button to confirm,
4. Push the 5-way button up/down to select the color you prefer: “Normal”, “Sepia”, “B & W”;
5. Press the “OK” button to confirm and return to the submenu of Camera;
6. Press “MENU” key can return to the Camera mode.

j. Quick preview

In Camera mode you can quick preview the latest image you capture.

1. In Camera mode, press “MENU” button to enter the submenu;

2. Push the 5-way button to select “quick preview”;
3. Press the “OK” button to confirm and select “on” or “off”;
4. Push the 5-way button upwards to select “on”;
5. Press the “OK” button to confirm and return to the submenu of Camera;
6. Press the “MENU” button to return to the Camera mode;
7. Press the “OK” button to confirm and quick preview the previous image. .

4.3. Playback

You can playback the video clip in the “Playback” mode.

1. Power on and enter video mode automatically ;
2. Press the “REC/PLAY” button to enter the main menu;
3. Push the 5-way button left/right to select the “playback” mode;
4. Press the “OK” button to confirm and enter the “playback” mode;
5. Press the “OK” button to play the video clips;
6. Press the “OK” button again to stop playing;
7. Push the 5-way button upwards to play the previous clip, push downwards to play the next clip.

Note:

1. This product is only available for AVI format on video playback mode;
2. The downloaded movie should be renamed; the file name should be “PICT” and followed by 4 numbers. For example, to download the movie named <I love this game> from your computer:
 - (1) Rename the movie as the file name of <PICT0050> in your computer and do not use the same name;

- (2) Copy the file <PICT0050> into the DCIM file folder of this product;
- (3) Disconnect the USB cable; the movie can be played in “playback” mode.

In “playback” mode, press the “menu” button to enter the submenu of delete, thumbnail, set logo, rotate, print, lock, crop and slide show.

Remarks: Rotate, print, crop and slide show function is not available in video playback mode.

a. Delete clip

You can enter the submenu of playback mode to delete the video clip.

1. In “playback” mode, press the “menu” button to enter the submenu;
2. Push the 5-way button to left/right to select “delete”;
3. Press the “OK” button to confirm and Push the 5-way button up/down to select “delete current” or “delete all”;
4. Press the “OK” button to confirm and select “yes” or “no”;
5. Select “yes” by the 5-way button and press the “OK” button to confirm.

b. Thumbnail

You can view the video clip quickly in thumbnail mode.

1. Under video mode, press the “menu” button to enter the submenu;
2. Select “thumbnail” by pushing the 5-way button left/right;
3. Press the “OK” button to confirm to preview all thumbnails;
4. You can preview each video by pushing the 5-way button;
5. When you select one video clip, press the “OK” button to preview full screen video clip.

C. set logo:

Same operation as the “logo display” (see page 11).

d. Lock:

The lock function can ensure you to protect the video clips or images;

1. Under “playback” mode, press the “menu” button to enter the submenu;
2. Select “lock” by push the 5-way button left/right to select “lock”;
3. Press the “OK” button to confirm, you can select “lock current”, “lock all”, “unlock current” and “unlock all”;
4. Push the 5-way button up/down to select “lock current” or “lock all”;
5. Press the “OK” button to confirm and return to the submenu of playback

Note: please select “unlock current” or “unlock all” when you want to unlock the video clip.

4.4 Music

You can play songs on “MUSIC” mode

1. Download the songs from PC to “mp3” folder of this product;
2. Power on and press “REC/PLAY” button to enter the main menu;
3. Push the 5-way button left/right to select “MUSIC” mode;
4. Press the OK button to confirm and enter the music mode;
5. Press the 5-way button to select the songs you prefer;
6. Press the “OK” button to play the songs;
7. Press the “OK” button again to stop the playing;
8. Push the 5-way button up/down to select next song;
9. Push the 5-way button left/right to adjust the volume.

4.5 . Photo preview

You can preview the photo in “Photo” mode.

1. Power on and press the “REC/PLAY” button to enter the main menu;
2. Push the 5-way button left/right to select “photo” mode;
3. Press the “OK” button to confirm and enter “photo” mode;
4. Push the 5-way button up/down to preview the images.

In the “photo” mode, press the “menu” button to enter the submenu to select “delete”, “thumbnail”, “set logo”, “rotate”, “print”, “lock”, “crop” and “slide show”.

a. Delete image

1. In the “Photo” mode, press the “MENU” button to enter the submenu;
2. Push the 5-way button left/right to select “delete”;
3. Press the “OK” button to confirm and select “delete current” or “delete all”;
4. Press the “OK” button to confirm and Push the 5-way button up/down to select “delete current” or “delete all”;
5. Press the “OK” button to confirm and select “yes” or “no”;
6. Select “yes” by the 5-way button and press the “OK” button to confirm.

b. Thumbnails

You can view the photos quickly in thumbnail mode.

6. Under video mode, press the “menu” button to enter the submenu;
7. Select “thumbnail” by pushing the 5-way button left/right;
8. Press the “OK” button to confirm to preview all thumbnails;
9. You can preview each image by pushing the 5-way button;

10. When you select one image, press the “OK” button to preview full screen image.

c. Play logo

Same operation as the “logo display” (see page 11).

d. Rotate

1. In “Photo” mode, press the “MENU” button to enter the submenu;
2. Push the 5-way button left/right to select “rotate”;
3. Press the “OK” button to confirm and select the “photo” mode;
4. Push the 5-way button up/down to rotate the photo;
5. Press the “OK” button to save the image after rotating, the setting is completed.

e. Lock

1. In “Photo” mode, press the “MENU” button to enter the submenu;
2. Push the 5-way button left/right to select “lock”;
3. Press the “OK” button to confirm and select “lock current”, “lock all”, “unlock current” or “unlock all”;
4. Push the 5-way button up/down to select,
5. Press the “OK” button to confirm and return to the submenu of photo mode, the setting is completed.

Note: please select “unlock current” or “unlock all” when you want to unlock the photo.

f. Crop

1. In the “photo” mode, select the image need to be cropped, press the “MENU” button to enter the submenu;

2. Push the 5-way button left/right to select “crop”;
3. Press the “OK” button to confirm
4. Push the 5-way button up/down/left/right to move the frame in the image to be cropped properly;
5. Press the “OK” button to crop and save.

g. Slide show

1. In “Photo” mode, press the “MENU” button to enter the submenu;
2. Push the 5-way button left/right to select “slide show”;
3. Press the “OK” button to confirm and select the image
4. Press the “OK” button again begins to display the images in slide show mode;
5. Press the “OK” button to end the slide show;
6. Push the 5-way button to the left to quit the slide show mode.

4.6. Record (voice recording)

1. Power on and press “REC/PLAY” button to enter “Setup” menu;
2. Push the 5-way button left/right to select “record” mode;
3. Press shutter to begin voice recording;
4. Press shutter again to stop recording.

Notice: the time of recording depends on the memory capacity.

5. USB mode

You can select different working modes when the product connects to PC.

1. PC CAMERA mode: You can use this product as a web cam in this mode;
2. Mass Storage mode: you can use this product as a removable device in this mode

3. DV mode: you can charge the lithium battery in this mode.

5.1 PC camera

Driver installation:

1. Insert the CD into CD-ROM, Click install camera driver

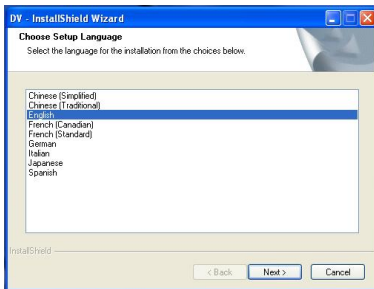

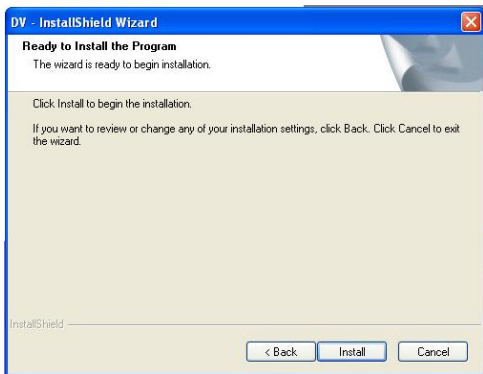

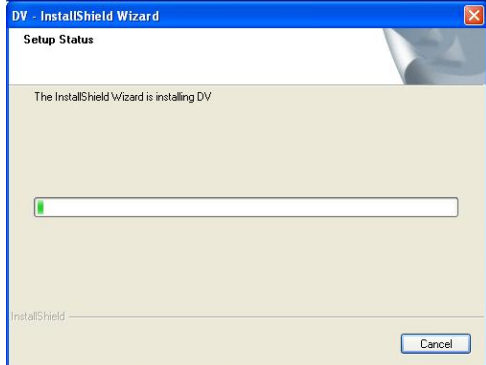

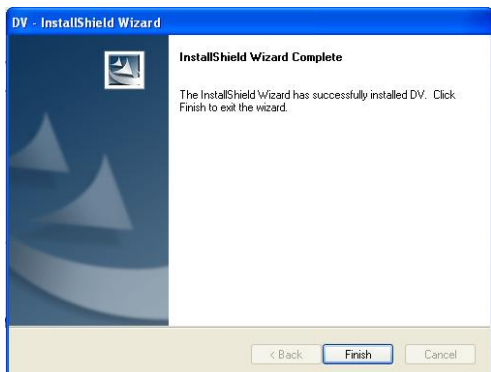

Connect the camera with PC by USB cable, Power on the DV, then push 5-way button to select "PC CAMERA";



An interface “Found new hardware Wizard” appears, select “Yes, this time only”, then click “next”;



Select “install the software automatically (Recommended)”, click “next”;

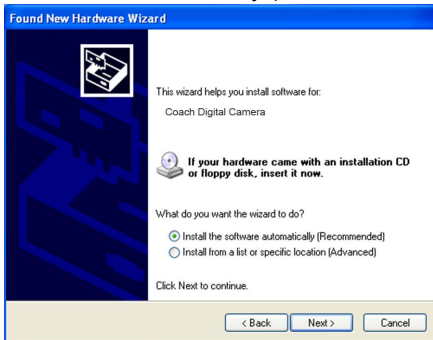

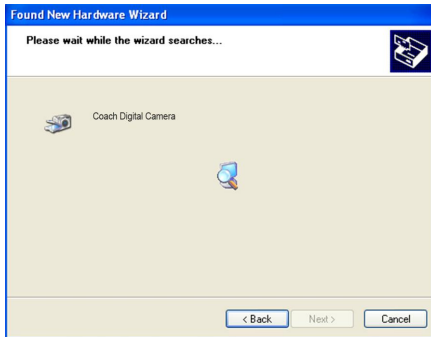

If “hardware installation” interface appears, click “Continue Anyway” ;

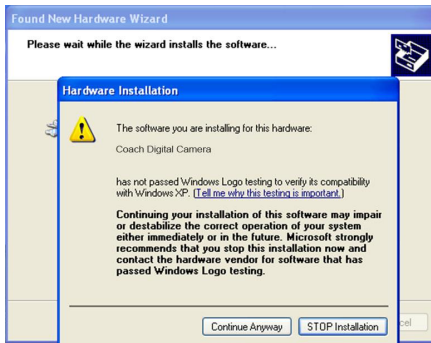





If the following interface appears, click “cancel”;



An interface “Found new hardware Wizard” appears, select “Yes, this time only”, then click “next”;



Select “install the software automatically (Recommended)”, click “next”;

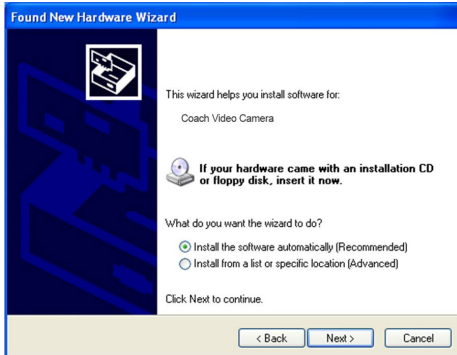



If “hardware installation” interface appears, click “Continue Anyway”;

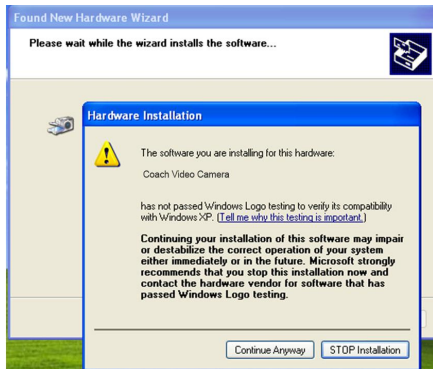

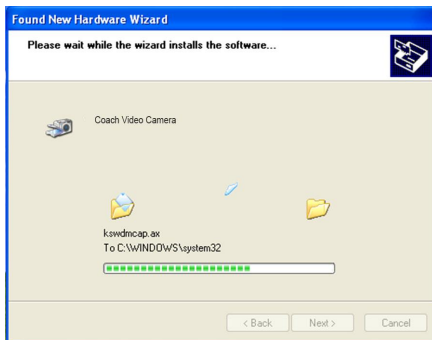

The installation is finished and now you can use the pc camera function;

2. How to use PC-CAM function

1. Connect this product to PC by USB cable;
2. Power on and select “PC Camera” mode;
3. Press the “OK” button to confirm;
 1. Double click the icon “my computer” on the desktop of PC
 2. Double click the icon “,” Then you can start to use the pc-cam function

5.2 Removable Storage device

Select the USB mode to “Mass Storage”, this product will be a removable storage device.

Download files from this product to your PC:

1. Connect this product with PC by USB cable;
2. Power on and select “Mass Storage”;
3. Press the “OK” button to confirm;
4. Double click icon “my computer” on desktop;
5. Double click icon “removable disk”;
6. Double click “DCIM” folder;
7. Copy the file from the folder to your PC.

Notice: Do not open the battery door to take out the battery or SD card when you download files, or else, it may cause damage of the file.

6. Technical parameters:

Sensor	5 mega pixels CMOS
Resolution	3648X2736, 2592x1944, 2048x1536, 1600x1200, 1280x960, 640x480
Medium	SD card compatible (8 MB – 1GB)
Format	MP3/Jpeg / AVI / Wav
Shooting mode	Single, continuous [(1280X960) 3 frames] 10s and 20s timing shooting Movie:
Shutter speed	
Digital zoom	4x
White balance	auto, daylight, incandescent, fluorescent, cloudy;
Exposure control	Auto
Exposure	
Flash mode	Force on, auto, force off

ISO	Auto
PC-Camera	640x480
Color	Normal, brown, B/W
PC connecting	USB
Video output	NTSC/PAL
Displayer	2.0" TFT color LCD resolution 640x480
Power	Lithium battery 3.7V/800mAH
OSD language	English, French, German, Spanish, Italian,
Focus	F = 7.36mm
Aperture	F = 3.2
Focus range	1.5m to infinite
Auto shutoff	Auto 60Sec 2Min
Operation	Microsoft Windows 98SE, ME, 2000, XP, Vista

If you need help, please contact Argus Camera Company Technical Support

Email – support@arguscamera.com

Toll-Free – 888-552-7487